

## F 3193 M1 MODEL - TYPE 1

### SHAFT TYPE, SWINGING FIRE HOSE REELS

Fetaş F 3193 M1 model fire hose reels are a product group designed for the general purpose of against the fire and can be easily used by everyone. Suitable for shaft space and similar area applications in structures.

It is one of the indispensable accessories of modern architects, as well as the functionality of the fire hose reel, which creates a visual impact in the places where it is used and provides easy access in case of an emergency.

#### GENERAL FEATURES

Swinging type fire hose reel with 30m semi-rigid hose. Demountable fire hose reels suitable for indoor usage, EN 671-1 standard, CE approved.

#### HOSE REEL TYPE - 1

- The reel system is manufactured in accordance with EN 671-1 standard.
- It is central water-fed, 270° swing arm type, semi-rigid hose reel.
- RAL 9005 black, polyester powder coated reel handle, with silkscreen printed pictographic instructions for use.
- Pressed-reinforced reel mounting plate made of 2mm DKP sheet, which can be fixed to the wall.
- All waterways are made of **brass** and corrosion-resistant **composite** materials.
- **Iron phosphate** coating on DKP steel material and topcoat **polyester** powder paint coating.
- **The service cover**, which contains **serigraphy printing**, **pictographic usage** and product information, provides ease of maintenance.
- DN 52 - PN 16 **brass** fire valve and Storz coupling in Light Alu.
- DN52 - DN25 tail Storz adaptor in light Alu.
- Reel hub in **brass** material with **4 o-ring seals and bearings**.
- Semi-rigid fire hose in accordance with EN 694 standard.
- Reinforced semi-rigid interconnection hose conforming to EN 694 standard.
- DN 25 jet-spray-off nozzle.
- **Galvanized** ring press, plastic **tubing covered** connection points.
- Standard colors are RAL3002 red, RAL 9010 white, RAL 9005 black. It can also be produced in a different color in the desired RAL code or as Matt (Satined) / Glossy (Polished) stainless chrome.
- Reel system that has passed **100%** leak seal and quality tests.

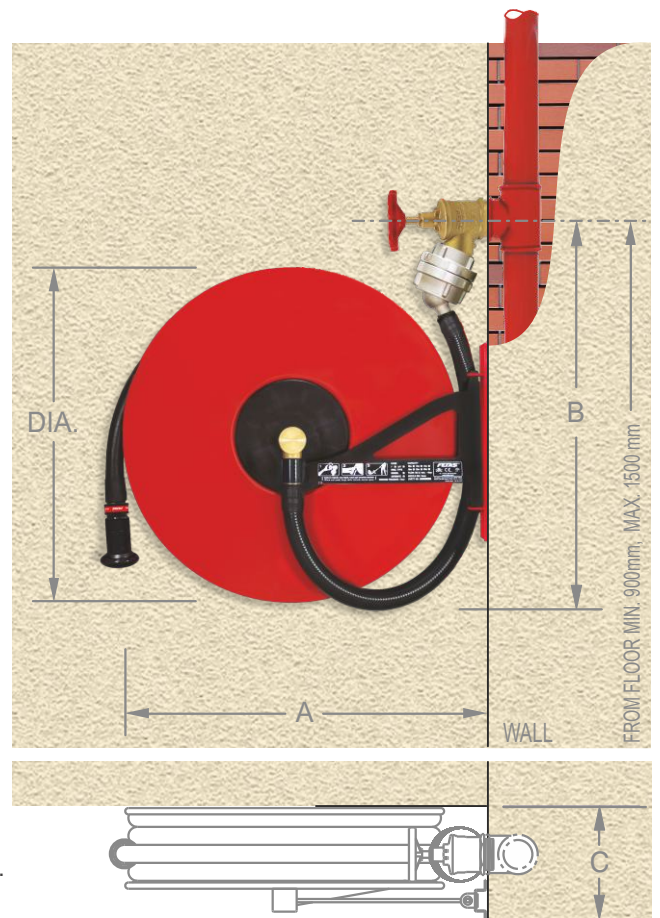

MODEL	HOSE CAPACITY	DIMENSIONS (mm)			
		DIA.	A	B	C
F 3193 M1	30m	Ø600	680	600	200

#### MOVEMENT OF THE 270° SWINGING REEL

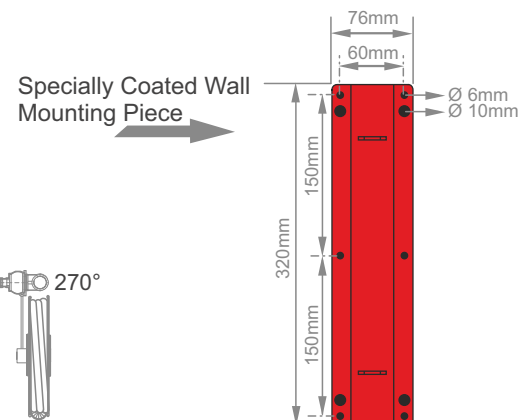
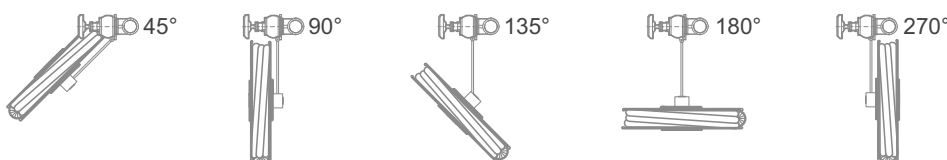

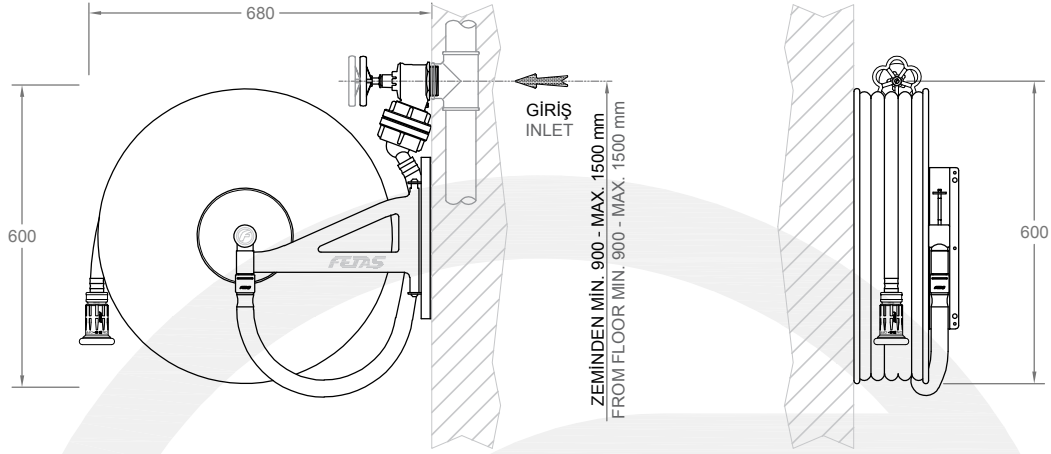
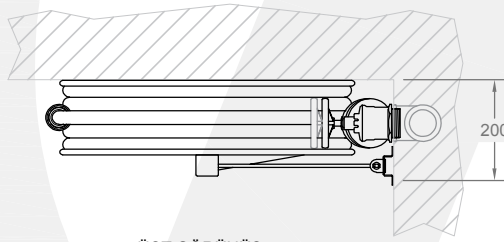
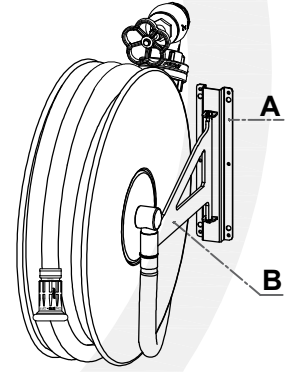
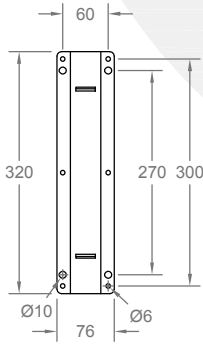
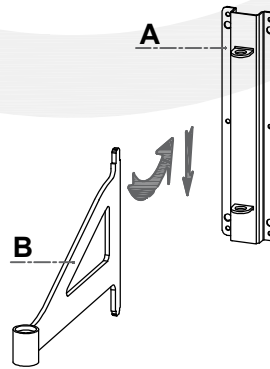
ÖN GÖRÜNÜŞ  
FRONT VIEWYAN GÖRÜNÜŞ  
SIDE VIEWÜST GÖRÜNÜŞ  
TOP VIEWİZOMETRİK ÖN GÖRÜNÜŞ  
ISOMETRIC FRONT VIEWDUVAR MONTAJ PLAKASI  
WALL MOUNTING PLATEMAKARA MONTAJ YÖNÜ  
HOSE REELS FIXING DIRECTIONS

KAPASİTE / CAPACITY : ¾" 30m Hortum / ¾" 30m Hose

ÇİZEN / DRW. BY	Yasin DEMİR	YÜZEY FINISH	—	ÖLÇEK / SCALE	1 : 15	TR EN		
KONT. / CONT. BY	Emre YİĞİTTEKİN	MALZEME MATERIAL	—					
ONAY / APP. BY	Cihan TUNA	AĞIRLIK WEIGHT	—					
TARİH / DATE	03.09.2025	SAYFA PAGE	1 / 1	A4				
ÇİZİM KODU DRAWING CODE	F 3193 M1							<b>Fetaş Yangın Ekipmanları Makina Metal Sanayi ve Ticaret A.Ş.</b> Dağyaka Mah. 2035. Cad. Küme Evleri No: 51. Kahramankazan 06980 Ankara - TÜRKİYE Tel: +90. 444 96 69 info@fetas.com www.fetas.com

-Tüm hakları saklıdır. Bu belge, FETAŞ'tan yazılı izin alınmaksızın hiçbir şekilde üçüncü şahıslara çoğaltılamaz veya iletilemez. Ürünlerimizi geliştirmeye yönelik sürekli araştırma ve geliştirme çalışmaları yürütülmekte olup, bu nedenle önceden bildirimde bulunmaksızın herhangi bir teknik özelliği değiştirme hakkımız saklıdır.

-All rights reserved. Reproduction or issue to third parties in any form whatever is not permitted without written authority from FETAŞ. Continuous research and development is taking place to improve our products and therefore we reserve the right to change any specification without prior notice.